

# SWEEP

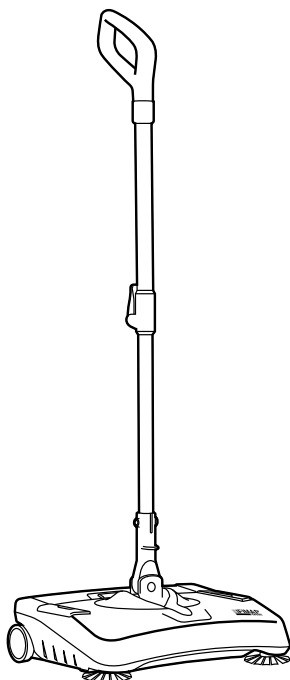

CORDLESS POWER SWEEPER

*USE AND MAINTENANCE MANUAL*



ORIGINAL INSTRUCTION DOC. 10057543 - Ver. AB - 02-2016



## CONTENTS

<i>SYMBOLS USED IN THE MANUAL</i> .....	4
<i>SYMBOLS USED ON THE MACHINE AND BATTERY CHARGER</i> .....	4
<i>PURPOSE AND CONTENT OF THE MANUAL</i> .....	5
<i>STORING THE USE AND MAINTENANCE MANUAL</i> .....	5
<i>ON DELIVERY OF THE APPLIANCE</i> .....	5
<i>INTRODUCTORY COMMENT</i> .....	5
<i>TECHNICAL DESCRIPTION</i> .....	5
<i>INTENDED USE</i> .....	5
<i>SAFETY</i> .....	5
<i>SERIAL NUMBER PLATE</i> .....	5
<i>SPARE PARTS</i> .....	6
<i>TECHNICAL DATA</i> .....	6
<i>GENERAL SAFETY REGULATIONS</i> .....	7
<i>HANDLING THE PACKED APPLIANCE</i> .....	11
<i>HOW TO UNPACK THE APPLIANCE</i> .....	11
<i>HOW TO TRANSPORT THE APPLIANCE</i> .....	11
<i>BATTERY TYPE</i> .....	11
<i>BATTERY MAINTENANCE AND DISPOSAL</i> .....	11
<i>RECHARGING THE BATTERY</i> .....	12
<i>PREPARING TO WORK</i> .....	13
<i>WORK</i> .....	13
<i>AT THE END OF THE WORK</i> .....	13
<i>MAINTENANCE</i> .....	14
<i>DISPOSAL</i> .....	14
<i>TROUBLESHOOTING</i> .....	15
<i>EC DECLARATION OF CONFORMITY</i> .....	16



The descriptions contained in this document are not binding. The company therefore reserves the right to make any modifications at any time to elements, details, or accessory supply, as considered necessary for reasons of improvement or manufacturing/commercial requirements. The reproduction, even partial, of the text and drawings contained in this document is prohibited by law.

**The company reserves the right to make any technical and/or supply modifications. The images are shown as a reference only, and are not binding as to the actual design and/or equipment.**

## SYMBOLS USED IN THE MANUAL



**Open book symbol with an “i”:**  
Indicates the need to consult the instruction manual.



**Open book symbol:**  
Tells the operator to read the manual before using the appliance.



**Covered place symbol:**  
the operations preceded by this symbol must always be carried out in a dry, covered area.



**Warning symbol:**  
Carefully read the sections marked with this symbol and observe the indications, for the safety of the operator and the appliance.



**Protective gloves symbol:**  
Always wear protective gloves, to avoid the risk of serious injury to your hands.



**Tool symbol:**  
indicates the need to use tools not included in the supply.



**Lifting point symbol:**  
located on the front and rear of the appliance, to indicate the lifting points.



**Explosion risk symbol:**  
indicates that the battery may explode in certain conditions, if not handled in accordance with the directives indicated in the manufacturer's manual.



**Disposal symbol:**  
carefully read the sections marked with this symbol for disposing of the appliance.



**Recycling symbol:**  
carefully read the sections marked with this symbol for recycling the appliance.

## SYMBOLS USED ON THE MACHINE AND BATTERY CHARGER



**Main switch symbol:**  
located on the central rear part of the appliance, to indicate the main switch.



**Battery symbol:**  
used on the left side of the appliance, to indicate the position of the battery.

OPEN

**“OPEN” symbol:**  
used on the rear of the appliance, to indicate the position of the debris hopper uncoupling button.



Power

**“Power” symbol:**  
used in the battery charger base, to indicate the green LED. This LED shows when the electric circuit is operating.



Charging

**“Charging” symbol:**  
used in the battery charger base, to indicate the red LED. This LED shows when the battery is recharging.

## PURPOSE AND CONTENT OF THE MANUAL

The aim of this manual is to provide customers with all the information needed to use the appliance in the safest, most appropriate and most autonomous way. It includes information concerning technical aspects, safety, operation, appliance downtime, maintenance, spare parts and scrapping. Operators and qualified technicians must read

the instructions in this manual carefully before carrying out any operation on the appliance. If in doubt about the correct interpretation of instructions, contact your nearest Customer Service Centre to obtain the necessary clarifications.

## STORING THE USE AND MAINTENANCE MANUAL

The Use and Maintenance Manual must be stored in its special pouch close to the appliance, protected from liquids and anything

else that could compromise its legibility.

## ON DELIVERY OF THE APPLIANCE

When the machine is delivered to the customer, an immediate check must be performed to ensure all the material mentioned in the shipping documents has been received, in addition to verifying that the equipment has not been damaged during transportation. If

this is the case, the carrier must ascertain the extent of the damage at once, informing our customer service office. It is only by prompt action of this type that the missing material can be obtained, and compensation for damage successfully claimed.

## INTRODUCTORY COMMENT

Any type of equipment can only work properly and effectively if used correctly and kept in full working order by performing the maintenance operations described in the attached documentation. You should therefore read this instruction manual carefully, consulting it again if issues arise while using the machine. If necessary, remember that

our assistance service (organised in collaboration with our dealers) is always available for advice or direct intervention.

## TECHNICAL DESCRIPTION

Sweep is an electric battery-powered brush designed for cleaning dry surfaces in both outdoor and indoor environments. The appliance has: a central brush for collecting the dirt, two side brushes for

cleaning in corners, and a debris hopper for holding the dirt. Do not use the appliance for purposes other than the one indicated above.

## INTENDED USE

This electric brush was designed and built to be used by a qualified operator to clean smooth, compact flooring in the commercial, residential and industrial sectors, in proven safety conditions. The appliance is only suitable for use in indoor - or at least covered - areas. The appliance is not suitable for use in the rain, or under jets of water.



**WARNING:** *It is forbidden to use the appliance for picking up dangerous dusts or inflammable liquids in places with an explosive atmosphere.*

## SAFETY

Operator cooperation is paramount for accident prevention. No accident prevention programme can be effective without the full co-operation of the operator who is directly responsible for machine operation. The majority of occupational accidents that happen both in the workplace or whilst moving are caused by failure to respect

the most basic safety rules. An attentive, careful operator is most effective guarantee against accidents and is fundamental in order to implement any prevention programme.

## SERIAL NUMBER PLATE

The serial number plate is located on the lower part of the appliance, indicating its general characteristics (in particular, the serial number). The serial number is a very important piece of information and should always be provided together with any request for assistance or when purchasing spare parts.

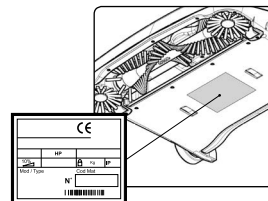

## SPARE PARTS

POS.	CODE	QTY	DESCRIPTION
1	224069	1	Command handle
2	224072	1	Dummy battery
3	224071	1	Debris hopper
4	224073	1	Power supply battery
5	224074	1	Battery charger base
6	224464	1	Brushes

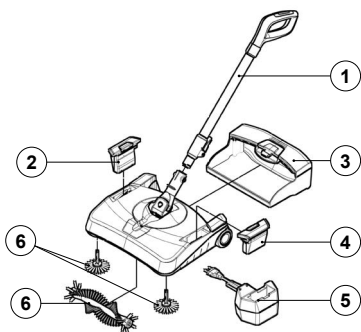

TECHNICAL DATA	U/M	Sweep
Working width	mm	375
Working capacity, up to	m <sup>2</sup> /h	1480
Central brush (number / diameter)	No. / Ømm	1 / 70
Side brush (number / diameter)	No. / Ømm	2 / 73
Central brush rpm	rpm	2115
Side brush rpm	rpm	940
Brush motor	V/W	10.8 / 70
Total power	W	70
Maximum gradient	%	2
Debris hopper volume	l	2
Appliance length	mm	310
Appliance height	mm	137
Height of the fully extended handlebar (idle position)	mm	1100
Appliance width	mm	368
Rated battery voltage	V	10.8
Battery autonomy	min	45
Battery weight	kg	0.197
Unladen appliance weight	kg	2.4
Appliance weight in running order	kg	2.8

## GENERAL SAFETY REGULATIONS

The regulations below must be carefully followed in order to avoid harm to the operator and damage to the appliance.

### **CAUTION:**

- Carefully read the warnings contained in this booklet and take care of it for further consultations.
- Since the packaging elements (plastic bags, staples, etc.) are a source of danger they should not be left within the reach of children, disabled persons, etc.
- This appliance should only be used for the purpose for which it was constructed, namely: cleaning inert surfaces and collecting non-flammable and non-explosive solid substances. Any other use is considered incorrect and hence dangerous.
- When the appliance is operating do not bring it close to delicate organs like ears, mouth, eyes, etc.
- The appliance can be used by children over 8 years of age and by people with limited physical, sensorial or mental, or by people who have no experience or the required knowledge, as long as they are supervised or after they have been given instruction regarding using the appliance safely and they understand the dangers involved in using it.
- Children should not play with the appliance.
- Children should not clean or carry out maintenance operations without the supervision of an adult.
- Carefully read the labels on the appliance. Do not cover them for any reason and replace them immediately if they become damaged.
- The appliance must be only used by authorised, trained personnel.
- Do not use the appliance on surfaces with an inclination greater than the one shown on the serial number plate. The appliance is not suitable for cleaning rough or uneven floors.



Do not use the appliance on slopes.

- Make sure the power cable of the battery charger base is not damaged in any way (crushed, torn, etc.). Protect the cable from heat, oil and sharp edges. Regularly check the power cable for any damage such as the formation of cracks, or ageing. If you notice any damage, the cable must be replaced before using the machine (contact a specialised technician immediately).
- Do not cut off the plug on the battery charger base with the intention of replacing it with another plug as this may cause a dangerous situation.
- In the event of danger, immediately remove the battery from the appliance.
- Before carrying out maintenance work, switch off the appliance using the main switch and remove the supply battery from its housing.
- When using the appliance, pay attention to other people and especially to children.
- Only use the accessories supplied with the appliance or those specified in the instruction manual, the use of other accessories can compromise the safety of the appliance.
- When the appliance is not being used, the battery should not be left connected to the appliance.
- Do not immerse the appliance in water. Do not use solvents or other derivatives to clean it.
- The manufacturer cannot be held liable for any damage to persons, animal or objects deriving from improper and unreasonable use, and in any event not complying with the instructions mentioned above.
- For scrapping, follow the regulations in force in the country.
- Before connecting the battery charger base to the socket, make sure the electrical information on the plate corresponds to that of the mains supply. The battery charger base must only be powered with a voltage equal to that shown on the serial number plate.



## **WARNING:**

- The appliance must not be used or kept outdoors, in damp conditions or directly exposed to rain.
- The appliance must be stored in an enclosed area with a temperature between  $-25^{\circ}\text{C}$  and  $+55^{\circ}\text{C}$ .
- Conditions of use: room temperature between  $0^{\circ}\text{C}$  and  $40^{\circ}\text{C}$ , with relative humidity between 30 and 95%.
- The socket for the battery power cable must have an earth connection in compliance with the regulatory standards.
- The appliance does not cause harmful vibrations.
- Never pick up gases, explosive/inflammable liquids or powders, nor acids and solvents! These include gasoline, paint thinners and fuel oil (which, when mixed with the vacuum air, can form explosive vapours or mixtures), and also non-diluted acids and solvents, acetones, aluminium and magnesium powders. These substances may also corrode the materials used to construct the appliance.
- If the appliance is to be used in dangerous areas (for example, gas stations), ensure that all relevant safety regulations are observed. The appliance must never be used in environments with a potentially explosive atmosphere.
- Do not place any liquid containers on the appliance.
- In the event of a fire, use a powder extinguisher. Do not use water.
- Adapt the speed to the adhesion conditions.
- Avoid working with the brushes when the machine is standing still, so as not to damage the floor.
- Do not knock against shelving or scaffolding, where there is a danger of falling objects. The operator must always be equipped with the appropriate safety devices (gloves, shoes, helmet, goggles, etc.).
- If the appliance does not work properly, check this is not caused by failure to carry out routine maintenance. Otherwise, ask for

intervention of the authorised technical assistance centre.

- If you need to replace any components, request the ORIGINAL spare parts from an Authorised dealer and/or Retailer.
- Restore all electrical connections after any maintenance interventions.
- Have the appliance checked by an authorised technical assistance centre every year.
- When disposing of consumable materials, observe the laws and regulations in force. When, after years of valuable work, your appliance needs to be finally decommissioned, dispose of the materials contained within it appropriately, bearing in mind that the appliance is made of fully recyclable materials.

## HANDLING THE PACKED APPLIANCE

Move the package using the handle. The overall weight of the appliance with its packaging is 4.5 kg (weight of the empty machine plus accessories and packaging). Since the packaging elements (plastic bags, staples, etc.) are a potential source of danger, they should not be left within the reach of children, disabled persons, etc.

The dimensions of the package are as follows:

**A : 370 mm**  
**B : 600 mm**  
**C : 170 mm**

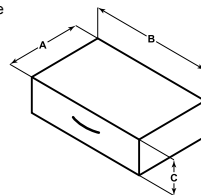

## HOW TO UNPACK THE APPLIANCE

The procedure for removing the device from its packaging is the following:

1. Open the outer box.
2. Remove the accessories from the box and carefully lay them on the ground.
3. Take the appliance out of the box.



**Warning:** it is recommended that all the packaging components be kept for any future transportation of the appliance.

**Warning:** you are advised to always wear protective gloves, to avoid any risk of serious injury to your hands.

## HOW TO TRANSPORT THE APPLIANCE

The procedure for the safe handling of the device is the following:

1. To remove the power battery (1) from the appliance, you must first free it by shifting the stop lever (2) towards the outer part of the machine. Lift the battery out of the appliance (Fig. 1).
2. Rotate the command handlebar in the direction of the arrow (Fig. 2).
3. Close the command handlebar, pushing the handle towards the main part of the appliance (Fig. 3).

4. Rotate the command handlebar in the direction of the arrow (Fig. 4).



**Warning:** when transporting the appliance on vehicles, secure it according to the directives in force so that it cannot slide or tip over.

**Warning:** users are advised to always wear protective gloves, to avoid the risk of serious injury to hands.

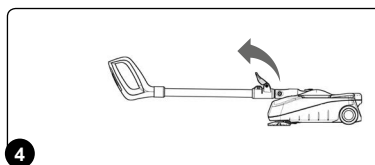
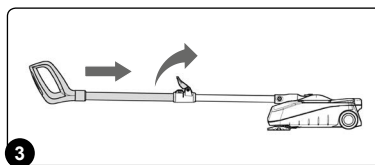
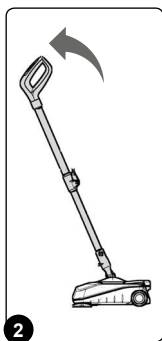
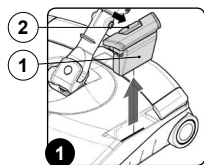

## BATTERY TYPE

To power the appliance, use only the battery supplied in the package or by a specialised technician.

**OTHER BATTERY TYPES CANNOT BE USED.**

The appliance is powered by a lithium-ion battery. The battery compartment can house a single 10.8 V battery slot.

## BATTERY MAINTENANCE AND DISPOSAL

For maintenance and recharging, respect the instructions provided by the battery manufacturer. When the battery is run down, you must take it to an authorised disposal centre.

**The battery is classified as dangerous waste, so it is compulsory to take it to an authorised disposal centre.**

For good battery maintenance, follow these indications:

- Do not attempt to open the batteries for any reason whatsoever.
- Do not let the battery get dirty or wet.
- The battery must not be exposed to excessive heat (e.g. rays of sunshine, flames, etc.).
- Do not leave the battery in places where the temperature could

exceed 40°C.

- Always recharge the battery at a room temperature between 10°C and 40°C.
- Recharge the battery using the power supply unit supplied with the appliance.
- Do not attempt to recharge damaged batteries.
- The battery contacts must not touch metal parts, to avoid any risk of short-circuits.
- The battery must be kept far from metal objects, to avoid any risk of short-circuits.
- Do not throw the battery into the fire.
- Do not throw the battery away with domestic waste; respect the

disposal regulations in force in the country where the appliance is used.

- Avoid any contact with the liquid that seeps out of damaged batteries. If you touch the liquid by accident, rinse your hands with water. If the liquid gets into your eyes, rinse it out and then contact a doctor.

For good battery charger maintenance, follow these indications:

- Only use the power supply unit delivered with the appliance to recharge the battery supplied by the manufacturer or by a specialised technician. Other batteries could explode, causing harm to people and damage to property.
- The voltage rate indicated on the plate in the battery charger must correspond to the mains voltage.
- Do not use the battery charger in potentially explosive environments.
- The battery charger contacts must not touch metal parts, to avoid any risk of short-circuits.
- Never attempt to recharge batteries that are not of the rechargeable type.
- Every time you want to use the battery charger and the battery, first make sure they are not damaged. Do not use damaged

appliances. Have faulty parts repaired by the staff of a technical assistance centre.

- Have any faulty supply wires replaced immediately.
- Do not let the power supply unit get dirty or wet.
- Do not open the power supply unit.
- Do not connect the power supply unit to probes.
- The batteries must be clean and dry when they are inserted in the battery charger.



**Warning:** the battery charger must only be used in a covered place.



**Warning:** read this manual before using the appliance or carrying out any maintenance work.



**Warning:** if the battery is handled in the wrong way, it could explode or release acids. This could cause burns and injuries to the people nearby.



**Warning:** when the battery is run down or damaged, respect the disposal regulations in force in the country of use.

## RECHARGING THE BATTERY

The battery must be charged prior to the first use, and when it doesn't provide enough power for tasks that could formerly be performed without difficulty. To recharge the battery, proceed as follows:

- Take the appliance to the dedicated battery recharging area.
- If the appliance is working, turn it off via the main switch (1) (Fig. 1).
- Block the handlebar in the vertical position.
- To remove the power battery (2) from the appliance, you must first free it by shifting the stop lever (3) in the direction of the arrow (Fig. 2). Lift the battery out of the appliance.



**Warning:** the room where the batteries are recharged must be adequately ventilated to prevent the accumulation of gases that leak from batteries.

**Warning:** during this operation, do not rest your foot on the appliance.

- Insert the battery (2) in the seat (4) in the battery charger, taking care to position the poles (5) in the battery correctly (Fig. 3).
- Insert the plug (6) on the battery charger power cable in the socket (7) on the battery charger base.



**Warning:** the battery can only be inserted in the power supply unit in one direction; do not force it in.

**Warning:** before inserting the plug (6) in the socket (7), make sure the battery housing compartment is not dirty (dust, condensation or other types of liquid).

- Insert the plug (8) on the battery charger power cable in the mains socket (9).
- As soon as the power cable plug is correctly inserted, the red LED (10) will light up and remain ON until the battery is fully charged.



**Warning:** the battery charger must only be used in a covered place.



**Warning:** read this manual before using the appliance or carrying out any maintenance work.



**Warning:** before connecting the plug (8) to the socket (9), make sure the characteristics of the mains supply correspond to those of the battery charger.

**Warning:** when you insert the plug (8) of the battery charger power supply unit in the socket (9) of the mains supply, make sure the green LED (11) on the battery charger lights up. This LED indicates that the battery charger circuit is correctly powered.

- It is recommended that the first battery charging cycle lasts at least 16-18 hours.
- Once the charging cycle is completed, remove the plug (8) on the battery charger power cable from the mains socket (9).
- To remove the power battery (2) from the battery charger base, you must first free it by shifting the stop lever (3) in the direction of the arrow. Lift the battery out of the appliance.



**Warning:** during the charging phase, the battery may overheat; this is normal and does not mean there is any problem with the battery.



**Warning:** if the battery used in this appliance is overcharged, there may be a risk of fire, explosion or chemical burns.

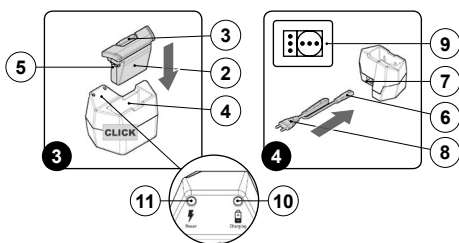
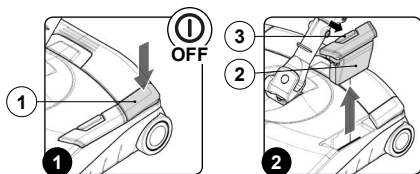

## PREPARING TO WORK

- Remove the appliance and all the accessories from the box (Fig. 1).
- Insert the lower tube (1) of the handlebar in the hole on the joint (2). Fix the handlebar to the joint using the screw and nut (3), making sure the hole (4) on the handlebar coincides with the hole on the joint (Fig. 2).
- Insert the pin (5) of the brush in the slot (6) on the lower part of the appliance and push it in until the brush is locked in place (Fig. 3). Repeat the operation for the other brush.
- Insert the dummy battery (7) in its compartment (8) on the right side of the appliance, making sure the dummy battery fixing pins are facing towards the rear of the appliance (Fig. 4). Press the dummy battery until the clamp (9) is in place.
- Insert the battery (10) in its compartment (11) on the left side of the appliance, making sure the battery poles (12) are facing towards the front of the appliance (Fig. 5). Press the battery until the clamp (13) is in place.
- Rotate the stop lever of the command handlebar (14) in the direction of the arrow (Fig. 6). Extend or reduce the length of the handlebar by means of the handle. The handlebar length must guarantee a feeling of comfort when using the appliance.

**Warning:** the screwdriver is not supplied.

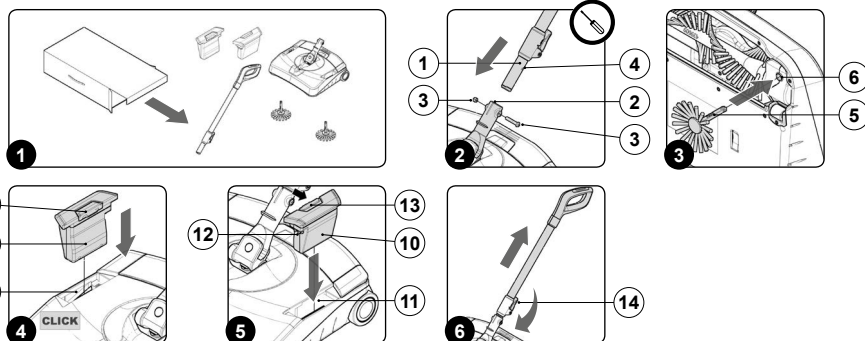

## WORK

- Before using the appliance, make sure it is in a good, safe working condition. If everything is not in order, the appliance must not be used.
- Carry out the phases described in the PREPARING TO WORK chapter.
- Activate the appliance by means of the button (1).
- The appliance will now work efficiently until the battery runs down.

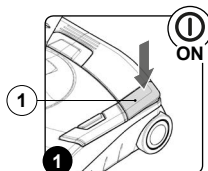

## AT THE END OF THE WORK

- Switch off the appliance using the button (1) (Fig. 1).
- Take it to the dedicated drainage area.
- Block the handlebar in the vertical position. Rest your foot on the main part of the appliance to prevent it from tilting, then push the handle away from you until it snaps into the vertical position.
- Release the lever (4) in the debris hopper, using the handle (5), then remove it from the appliance (Fig. 3).
- Use the handle (5) on the back of the debris hopper to take it to the drainage area, then empty it.
- Use a damp cloth to clean the inside and outside of the debris hopper.
- Repeat the operations in reverse order to reassemble the debris hopper.
- To remove the power battery (2) from the appliance, you must first free it by shifting the stop lever (3) towards the outer part of the machine. Lift the battery out of the appliance (Fig. 2).

**Warning:** do not rest your foot on the main switch or on the debris hopper uncoupling lever.

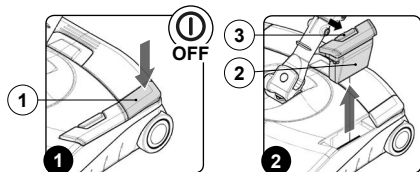

9. Block the handlebar in the horizontal position. Rest your foot on the main part of the appliance to prevent it from tilting, then push the handle away from you until it snaps into the horizontal position.

**Warning:** do not rest your foot on the main switch or on the debris hopper uncoupling lever.

10. Rotate the stop lever of the command handlebar (6) in the direction of the arrow (Fig. 4).  
11. Close the command handlebar, pushing the handle (7) towards the main part of the appliance.

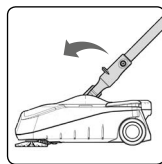
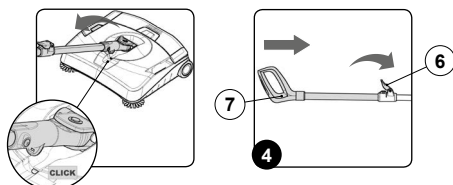

12. Rotate the stop lever of the command handlebar (6) in the direction of the arrow (Fig. 5).

13. Take the appliance to the designated machine storage place.  
14. Position the appliance with its rear part in contact with the floor. In this position, the brushes are not in contact with the floor and cannot suffer any deformation caused by the weight of the appliance (Fig. 6).

**Warning:** park the appliance in an enclosed place, on a flat surface; near the appliance there must be no objects that could either damage it, or be damaged through contact with it.

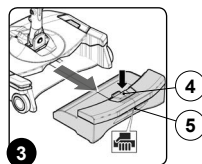

## MAINTENANCE

1. Switch off the appliance using the button (1) (Fig. 1).  
2. To remove the power battery (2) from the appliance, you must first free it by shifting the stop lever (3) towards the outer part of the machine. Lift the battery out of the appliance (Fig. 2).  
3. Empty the hopper (see the AT THE END OF THE WORK chapter).  
4. Position the appliance with its rear part in contact with the floor.  
5. Take the disc brushes (2) out of their seats by pulling them in the direction of the arrow (Fig. 3). Remove any fluff, hairs etc. from the disc brushes. Check the bristles are not worn; in the event of excessive wear, replace the brushes.

6. Take the cylindrical brush (3) out of its seat by shifting it to the left side (arrow A) of the appliance and at the same time removing it (arrow B) from its support (Fig. 4). Remove any fluff, hairs etc. from the cylindrical brush. Check the bristles are not worn; in the event of excessive wear, replace the brush.

**Warning:** using a vacuum cleaner remove any dirt in the compartment housing the brushes.

7. Repeat the operations in reverse order to reassemble all the parts.

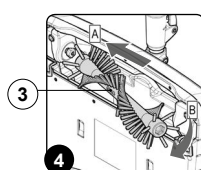
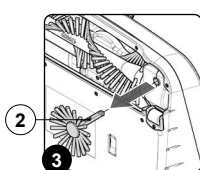
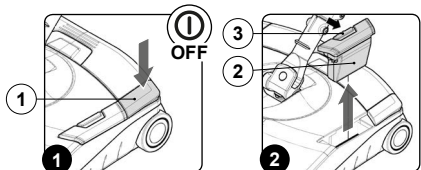

## DISPOSAL

To dispose of the appliance, take it to a demolition centre or an authorised collection centre. Before scrapping the appliance, it is necessary to remove and separate out the following materials, then send them to the appropriate collection centres in accordance with applicable environmental hygiene regulations:

- Brushes
- Electric and electronic parts (contact your local distributor when scrapping electric and electronic parts)
- Batteries
- Plastic and metal parts
- Packaging elements (paper or cardboard)

**Warning:** separate waste collection. This product must not be disposed of with normal domestic waste.

**Warning:** discharge the battery completely before disposing of it.

**Warning:** the separate waste collection of the products and their packaging means that materials can be recycled and used again. Re-using the materials helps protect the environment, preventing pollution and the constant need for raw materials.

## TROUBLESHOOTING

This chapter lists the most common problems linked with the use of the appliance. If you are unable to resolve the problems with the information given here, please contact your nearest assistance centre.

PROBLEM	POSSIBLE CAUSE	SOLUTION
<b>The appliance doesn't work.</b>	The battery/batteries is/are not charged.	Charge the battery/batteries.
<b>The battery doesn't charge up.</b>	The plug on the power cable of the battery charger base isn't correctly inserted in the mains socket.	Insert the plug of the battery charger base correctly in the mains socket.
	The plug on the power cable of the battery charger base isn't correctly inserted in the socket on the battery charger base.	Insert the plug correctly in the socket on the battery charger base.
	The appliance wasn't switched off correctly.	Switch off the appliance using the ON/OFF button.
<b>The appliance doesn't pick up all the dirt.</b>	The debris hopper is full.	Empty the debris hopper.
	The cylindrical brush is blocked.	Clean the cylindrical brush.
	The cylindrical brush is worn.	Replace the cylindrical brush.
<b>Dust emerges from the appliance.</b>	The debris hopper is full.	Empty the debris hopper.
	The debris hopper isn't fully closed.	Make sure the debris hopper is correctly inserted in the appliance. If the debris hopper is correctly inserted, the uncoupling lever closes automatically with a CLICK.
<b>The appliance is noisy and unmanageable.</b>	Dirt has built up around the disc brushes or the cylindrical brush.	Clean the disc brushes and the cylindrical brush.
	Dirt has built up around the front or rear wheels.	Contact your nearest assistance centre.
<b>The appliance has limited work autonomy.</b>	The battery wasn't correctly charged.	Discharge the battery completely by leaving the appliance ON until it switches off., then recharge the battery.
	The battery is dead (it has reached the end of its working life).	Replace the battery with a new one.



## EC DECLARATION OF CONFORMITY



The undersigned company:  
**Industrial Cleaning Equipment Ltd.**  
Sauber House, Unit 3, Rushington Business Park  
Chapel Lane, Totton, Hampshire, SO40 9AH

Declares under its sole responsibility that the products

### **ELECTRIC BRUSH, "Sweep" model**

Comply with the requirements of the following Directives:

- 2006/95/EC.
- 2004/108/EC

They also comply with the following standards:

- EN 55014 - 1: 2006 + A1: 2009
- EN 55014 - 2: 1997 + A2: 2008
- EN 60335 - 1
- EN 60335 - 2 - 10
- EN 60335 - 2 - 29
- EN 61000 - 3 - 2: 2006 + A2: 2009
- EN 61000 - 3 - 3: 2008
- EN 62233: 2008
- 

The person authorised to compile the technical file:

Mr. Mark Bresnihan  
Sauber House, Unit 3, Rushington Business Park  
Chapel Lane, Totton, Hampshire, SO40 9AH

Chapel Lane, 06/10/2014

### **Industrial Cleaning Equipment Ltd.**

Legal representative  
Mark Bresnihan

### **Manufacturer:**

#### **FIMAP S.p.A.**

Via Invalidi del Lavoro, n°1  
c.a.p. 37059 - S. Maria di Zevio (VR) - Verona - Italia  
Tel. +39 045 6060411 - Fax. +39 045 6060417  
E-mail: [fimap@fimap.com](mailto:fimap@fimap.com)  
Web: [www.fimap.com](http://www.fimap.com)

### **Mandatory:**

#### **Industrial Cleaning Equipment Ltd.**

Sauber House, Unit 3, Rushington Business Park  
Chapel Lane, Totton, Hampshire, SO40 9AH  
Tel. 0800 389 3869 - Fax. 023 8042 8318  
E-mail: [info@ice-clean.com](mailto:info@ice-clean.com)  
Web: [www.ice-clean.com](http://www.ice-clean.com)



**NOTE**

A large rectangular area with horizontal lines, intended for taking notes. The lines are evenly spaced and cover the majority of the page's width and height.







**Industrial Cleaning Equipment Ltd.**

Sauber House, Unit 3, Rushington Business Park - Chapel Lane, Totton, Hampshire, SO40 9AH  
Service 0800 389 3869 - Facsimile 023 8042 8318 - Email [info@ice-clean.com](mailto:info@ice-clean.com)