

MOP

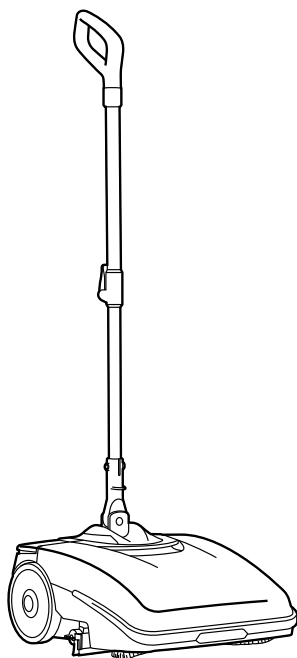

COMMERCIAL AUTOSCRUBBER

USE AND MAINTENANCE MANUAL



TRANSLATION OF THE ORIGINAL INSTRUCTION
DOC. 10057541 - Ver. AB - 01-2016

CONTENTS

<i>SYMBOLS USED IN THE MANUAL</i>	2
<i>SYMBOLS USED ON THE APPLIANCE</i>	2
<i>PURPOSE AND CONTENT OF THE MANUAL</i>	3
<i>TARGET GROUP</i>	3
<i>STORING THE USE AND MAINTENANCE MANUAL</i>	3
<i>ON DELIVERY OF THE APPLIANCE</i>	3
<i>INTRODUCTORY COMMENT</i>	3
<i>IDENTIFICATION DATA</i>	3
<i>TECHNICAL DESCRIPTION</i>	3
<i>INTENDED USE</i>	3
<i>SAFETY</i>	3
<i>SERIAL NUMBER PLATE</i>	3
<i>TECHNICAL DATA</i>	4
<i>SPARE PARTS</i>	4
<i>GENERAL SAFETY REGULATIONS</i>	5
<i>HANDLING THE PACKED APPLIANCE</i>	8
<i>HOW TO UNPACK THE APPLIANCE</i>	8
<i>HOW TO TRANSPORT THE APPLIANCE</i>	8
<i>BATTERY TYPE</i>	9
<i>RECHARGING THE BATTERY</i>	9
<i>PREPARING THE APPLIANCE</i>	10
<i>PREPARING TO WORK</i>	11
<i>WORK</i>	12
<i>AT THE END OF THE WORK</i>	13
<i>MAINTENANCE</i>	14
<i>TROUBLESHOOTING</i>	18
<i>DISPOSAL</i>	19
<i>EC DECLARATION OF CONFORMITY</i>	19

The descriptions contained in this document are not binding. The company therefore reserves the right to make any modifications at any time to elements, details, or accessory supply, as considered necessary for reasons of improvement or manufacturing/commercial requirements. The reproduction, even partial, of the text and drawings contained in this document is prohibited by law.

The company reserves the right to make any technical and/or supply modifications. The images are shown as a reference only, and are not binding as to the actual design and/or equipment.

SYMBOLS USED IN THE MANUAL

 **Open book symbol with an "i":**
Indicates the need to consult the instruction manual.

 **Open book symbol:**
Tells the operator to read the manual before using the appliance.

 **Covered place symbol:**
the operations preceded by this symbol must always be carried out in a dry, covered area.

 **Warning symbol:**
Carefully read the sections marked with this symbol and observe the indications, for the safety of the operator and the appliance.

 **Protective gloves symbol:**
Always wear protective gloves, to avoid the risk of serious injury to your hands.

 **Tool symbol:**
indicates the need to use tools not included in the supply.

 **Explosion risk symbol:**
indicates that the battery may explode in certain conditions, if not handled in accordance with the directives indicated in the manufacturer's manual.

 **Disposal symbol:**
carefully read the sections marked with this symbol for disposing of the appliance.

 **Recycling symbol:**
Informs the operator that the operations must be carried out in accordance with the environmental regulations in force in the place where the appliance is being used.

 **Tank drainage symbol:**
Informs the operator that the recovery tank must be emptied every time the solution tank is filled.

 **Recycling symbol:**
Carefully read the sections marked with this symbol in order to fill the solution tank correctly.

SYMBOLS USED ON THE APPLIANCE

 **Main switch symbol:**
Located on the rear part of the appliance, to indicate the main switch.

 **Solenoid valve switch symbol:**
Located on the rear part of the appliance, to indicate the solenoid valve switch.

 **Symbol for squeegee movement to "work position":**
Indicates the rotation direction of the squeegee control knob in order to bring the squeegee rubbers into contact with the floor.

 **Symbol for squeegee movement to "idle position":**
Indicates the rotation direction of the squeegee control knob in order to raise the squeegee rubbers off the floor.

 **Lifting point symbol:**
Indicates the location of the elements for lifting the appliance or moving mobile appliance parts.

OPEN **"OPEN" symbol:**
Located on the upper part of the appliance, to indicate the position of the handle for opening the front carter.

 **Warning symbol not to rotate the appliance:**
Indicates that the appliance must not be rotated when the tanks are full.

PURPOSE AND CONTENT OF THE MANUAL

The aim of this manual is to provide customers with all the information needed to use the appliance in the safest, most appropriate and most autonomous way. It includes information concerning technical aspects, safety, operation, appliance downtime, maintenance, spare parts and scrapping. Operators and qualified technicians must read

the instructions in this manual carefully before carrying out any operation on the appliance. If in doubt about the correct interpretation of instructions, contact your nearest Customer Service Centre to obtain the necessary clarifications.

TARGET GROUP

This manual is aimed at operators and qualified technicians responsible for appliance maintenance. Operators must not perform operations that should be carried out by qualified technicians. ICE

cannot be held liable for damages resulting from failure to comply with this prohibition.

STORING THE USE AND MAINTENANCE MANUAL

The Use and Maintenance Manual must be stored in its special pouch close to the appliance, protected from liquids and anything

else that could compromise its legibility.

ON DELIVERY OF THE APPLIANCE

When the machine is delivered to the customer, an immediate check must be performed to ensure all the material mentioned in the shipping documents has been received, in addition to verifying that the equipment has not been damaged during transportation. If

this is the case, the carrier must ascertain the extent of the damage at once, informing our customer service office. It is only by prompt action of this type that the missing material can be obtained, and compensation for damage successfully claimed.

INTRODUCTORY COMMENT

Any type of equipment can only work properly and effectively if used correctly and kept in full working order by performing the maintenance operations described in the attached documentation. You should therefore read this instruction manual carefully, consulting it again if issues arise while using the machine. If necessary, remember that

our assistance service (organised in collaboration with our dealers) is always available for advice or direct intervention.

IDENTIFICATION DATA

For technical assistance or to request replacement parts, always give the model, the version and serial number written on the serial

number plate.

TECHNICAL DESCRIPTION

The **MOP** is a scrubbing machine that cleans a wide range of flooring and dirt types by means of the mechanical action of the discoidal brush and the chemical action of a water-detergent solution. As it advances, it collects the dirt that has been removed and the

detergent solution that has not been absorbed by the floor. **The appliance must only be used for this purpose.**

INTENDED USE

This scrubbing machine was designed and built for the cleaning (scrubbing and drying) of smooth, compact flooring in the commercial, residential and industrial sectors by a qualified operator in proven safety conditions. The scrubbing machine is not suitable for cleaning rugs or carpets. The appliance is only suitable for use in indoor - or at least covered - areas.

 **ATTENTION:** The appliance is not suitable for use in the rain, or under jets of water.

IT IS FORBIDDEN to use the appliance for picking up dangerous dusts or inflammable liquids in places with an explosive atmosphere. In addition, it is not suitable as a means of transport for people or objects.

SAFETY

Operator cooperation is paramount for accident prevention. No accident prevention programme can be effective without the full co-operation of the operator who is directly responsible for machine operation. The majority of occupational accidents that happen both in the workplace or whilst moving are caused by failure to respect

the most basic safety rules. An attentive, careful operator is most effective guarantee against accidents and is fundamental in order to implement any prevention programme.

SERIAL NUMBER PLATE

The serial number plate is located in the power supply battery compartment on the rear part of the device, indicating its general characteristics (in particular, the serial number). The serial number is a very important piece of information and should always be provided together with any request for assistance or when purchasing spare parts.

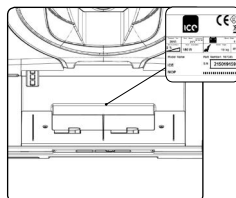

TECHNICAL DATA	U/M	MOP
Total power	W	150
Working width	mm	340
Working capacity, up to	m ² /h	680
Central brush (number / (diameter x length))	No. / (Ømm x mm)	1 / (110 x 340)
Brush motor (rated)	V/W	24 / 50
Vacuum motor (rated)	V/W	24 / 100
Maximum gradient	%	2
Solution tank capacity	l	1.2
Recovery tank capacity	l	1
Appliance length	mm	430
Appliance height	mm	215
Overall dimensions in standby position (LxHxL)	mm	395 x 1295 x 445

TECHNICAL DATA	U/M	MOP
Overall dimensions in idle position (LxHxL)	mm	395 x 915 x 365
Rated battery voltage	V / mAh	25.55 / 5200
Battery weight	kg	1
Empty weight (appliance + brush + squeegee)	kg	9
Appliance weight during transport (appliance + battery + brush + squeegee)	kg	10
Appliance weight in running order (appliance + battery + detergent solution + brush + squeegee)	kg	11.4
Sound pressure level (ISO 11201) - L pA	dB (A)	<70
Uncertainty KpA	dB (A)	1.5
Hand vibration level (ISO 5349)	m/s ²	<2.5
Vibration measurement uncertainty		4%

SPARE PARTS

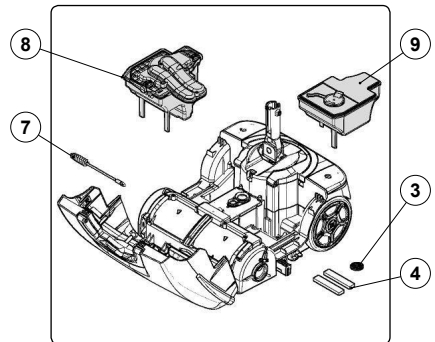
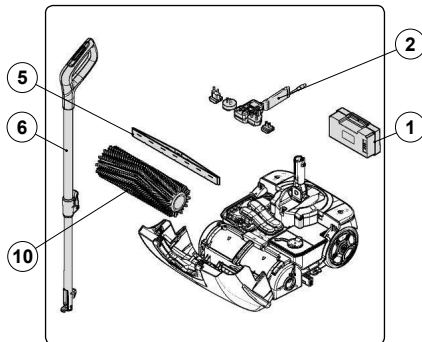

POS.	CODE	QTY	DESCRIPTION
1	440974	1	BATTERY
2	441033	1	BATTERY CHARGER
3	439888	1	CLEAN WATER FILTER
4	441025	2	ANTI-DUST FILTER
5	224800	1	SQUEEGEE RUBBER KIT
6	224615	1	CONTROL HANDLEBAR

POS.	CODE	QTY	DESCRIPTION
7	441023	1	TUBE-CLEANING BRUSH
8	224621	1	RECOVERY TANK
9	224619	1	SOLUTION TANK
10	440905	1	SOFT BRUSH
	440904	1	HARD BRUSH

GENERAL SAFETY REGULATIONS

The regulations below must be carefully followed in order to avoid harm to the operator and damage to the appliance.

WARNING:

- This appliance must not be used by people (including children) with reduced physical, sensorial and mental capabilities, or by people without any experience or knowledge, unless they have been controlled and instructed in the use of the appliance by people responsible for their safety. Children must be supervised to ensure they do not play with the appliance.
- The appliance must always be stored and used in a closed place.
- The appliance must be only used by authorised, trained personnel.
- Do not use the appliance on surfaces with an inclination greater than the one shown on the serial number plate.
- The appliance is not suitable for cleaning rough or uneven floors. Do not use the appliance on slopes.
- If the battery recharge cable is damaged, contact an authorised service centre immediately.
- In the event of danger, promptly remove the battery from the rear part of the appliance (refer to the “REMOVING THE BATTERY” paragraph).
- For all maintenance interventions, switch off the machine using the main switch and remove the battery.
- To prevent the appliance from being activated accidentally, the power supply must be disconnected, the appliance must be switched off using the main switch, and the battery must be removed.
- Children must be supervised to ensure they do not play with the device.
- When using the appliance, pay attention to other people and especially to children.

- Only use the brush supplied with the appliance, or supplied by a dealer or Authorised Retailer. The use of other brushes could compromise safety levels.
- The appliance must only be powered with a voltage equal to that shown on the serial number plate.
- When left unattended, the appliance must be protected from unintentional movements.



The appliance must not be transported or parked in its idle position when the solution tank and recovery tank are full.

ATTENTION:

- The appliance must not be used or kept outdoors, in damp conditions or directly exposed to rain.
- The appliance must be stored in an enclosed area with a temperature between -25°C and $+55^{\circ}\text{C}$.
- Conditions of use: room temperature between 0°C and 40°C , with relative humidity between 30 and 95%.
- The socket for the battery power cable must have a prescribed earth connection.
- The appliance does not cause harmful vibrations.
- Never pick up gases, explosive/inflammable liquids or powders, nor acids and solvents! These include gasoline, paint thinners and fuel oil (which, when mixed with the vacuum air, can form explosive vapours or mixtures), and also non-diluted acids and solvents, acetones, aluminium and magnesium powders. These substances may also corrode the materials used to construct the appliance.
- If the appliance is used in dangerous areas (e.g. petrol stations), the relative safety standards must be observed. The appliance must never be used in environments with a potentially explosive atmosphere.

- Do not place any liquid containers on the appliance.
- In the event of a fire, use a powder extinguisher. Do not use water.
- Adapt the speed to the adhesion conditions.
- Avoid using the brushes while the appliance is standing still, so as not to damage the floor.
- Do not knock against shelving or scaffolding, where there is a danger of falling objects. The operator must always be equipped with the appropriate safety devices (gloves, shoes, helmet, goggles, etc.).
- If the appliance does not work properly, check this is not caused by failure to carry out routine maintenance. Otherwise, ask for intervention of the authorised technical assistance centre.
- If you need to replace any components, request the ORIGINAL spare parts from an Authorised Retailer or dealer.
- Restore all electrical connections after any maintenance interventions.
- Have the appliance checked by an authorised technical assistance centre every year.
- When disposing of consumable materials, observe the laws and regulations in force. When, after years of valuable work, your appliance needs to be finally decommissioned, dispose of the materials contained in it appropriately, bearing in mind that the appliance is made of fully recyclable materials.

HANDLING THE PACKED APPLIANCE

Since the packaging elements (plastic bags, staples, etc.) are a potential source of danger, they should not be left within the reach of children, disabled persons, etc. The overall weight of device, including packaging, is 18kg

The dimensions of the package are as follows:

	U/M	MOP
A	mm	270
B	mm	487
C	mm	698

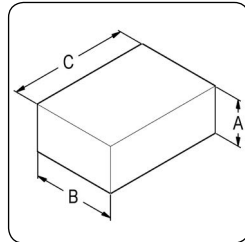

HOW TO UNPACK THE APPLIANCE

The procedure for removing the device from its packaging is the following:

1. Place the lower part of the outer packaging in contact with the floor.

! ATTENTION: Use the pictograms printed on the box as reference.

2. Open the outer box.
3. Remove the accessories from the box and carefully lay them on the ground.

4. Take the appliance out of the box.

! ATTENTION: it is recommended that all the packaging components be kept for any future transportation of the appliance.

! ATTENTION: these operations must be carried out using protective gloves to avoid any possible contact with the edges or tips of metal objects.

HOW TO TRANSPORT THE APPLIANCE

The procedure for the safe handling of the device is the following:

1. If the appliance is working, turn it off via the main switch (1) (Fig. 1).
2. Make sure the recovery tank is empty. If it isn't, empty it completely.
3. Make sure the solution tank is empty. If it isn't, empty it completely.
4. Remove the power battery (2) from the appliance. To free the battery, shift the stop lever (3) in the direction of the arrow (Fig.2).

5. Remove the battery from the appliance using the handle moulded on it (Fig.3).

! The appliance must not be transported or parked in its idle position when the solution tank and recovery tank are full.

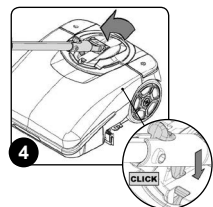
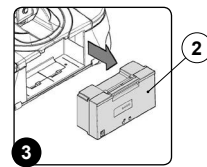
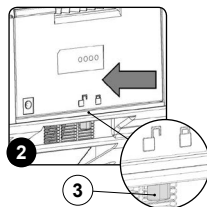
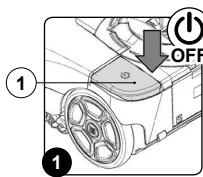

6. Block the handlebar in the horizontal position. Rest your foot on the main part of the appliance to prevent it from tilting, then push the handle away from you until it snaps into the horizontal position (Fig.4).

7. Rotate the stop lever of the command handlebar (4) in the direction of the arrow (Fig.5).

8. Close the command handlebar, pushing the handle (5) towards the main part of the appliance (Fig.6).

! ATTENTION: do not rest your foot on the main switch.

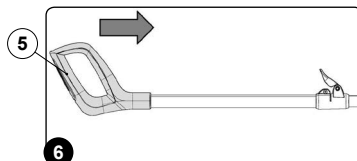
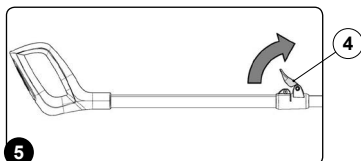

9. Rotate the stop lever of the command handlebar (4) in the direction of the arrow (Fig.7).
10. To raise the device off the floor, use the handle (6) on its rear (Fig.8)



ATTENTION: these operations must be carried out using protective gloves to avoid any possible contact with the edges or tips of metal objects.



ATTENTION: When transporting the appliance on vehicles, secure it according to the directives in force so that it cannot slide or tip over.

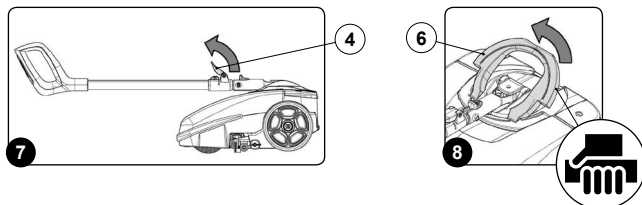

BATTERY TYPE

To power the appliance, use only the battery supplied in the package or by a specialised technician.

OTHER BATTERY TYPES CANNOT BE USED.

The appliance is powered by a lithium-ion battery. The battery compartment can accommodate a single battery slot at 25.55V.



ATTENTION: for the maintenance and disposal of the battery, refer to the document supplied by the battery manufacturer.

RECHARGING THE BATTERY

The battery must be charged prior to the first use, and when it doesn't provide enough power for tasks that could formerly be performed without difficulty. To recharge the battery, proceed as follows:

1. Take the appliance to the dedicated battery recharging area.



ATTENTION: the room where the batteries are recharged must be adequately ventilated to prevent the accumulation of gases that leak from batteries.

2. If the appliance is working, turn it off via the main switch (1) (Fig. 1).
3. Block the handlebar in the vertical position.



ATTENTION: during this operation, do not rest your foot on the appliance.



ATTENTION: before connecting the battery charger to the socket, make sure the characteristics of the mains supply correspond to those of the battery charger.



ATTENTION: the battery charger must only be used in a covered place.

5. Connect the power plug (2) to the mains supply.



ATTENTION: make sure the green LED (4) on the battery charger lights up when you enable the battery charger base circuit (Fig.3). This LED indicates that the battery charger circuit is correctly powered.

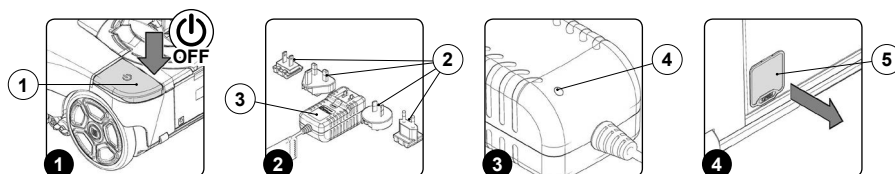

6. Remove the cap (5) covering the battery power socket (Fig.4).
7. Insert the battery charger power cable plug (6) in the socket (7) on the battery (Fig.5).



ATTENTION: before inserting the plug (6) in the socket (7), make sure the battery charger housing compartment is not dirty (dust, condensation or other types of liquid).



ATTENTION: make sure the green LED (4) on the battery charger lights up when you enable the charger (Fig.3). This LED indicates that the battery charger circuit is correctly powered.



ATTENTION: make sure the red LED (4) on the battery charger lights up when you insert the plug (6) in the socket (7). This LED indicates that the battery is recharging.

8. Perform a complete battery charging cycle.

⚠ ATTENTION: the red LED (4) remains on until the battery is fully charged. When the recharging cycle has ended, the red LED goes off and the green LED comes on.

⚠ ATTENTION: The charger and the battery can be left connected to the power outlet. The red LED (4) lights up when the charger occasionally tops up the battery.

⚠ ATTENTION: the red charge status LED (4) does not provide any indication of the battery charge level.

⚠ ATTENTION: during the charging phase, the battery may overheat. This is normal and does not mean there is any problem with the battery.

⚠ ATTENTION: if the battery used in this appliance is overcharged, there may be a risk of fire, explosion or chemical burns.

9. Once the charging cycle is completed, remove the plug (2) on the battery charger from the mains socket.

⚠ ATTENTION: to prevent any damage to the mains socket, pull directly on the plug (not on the cable) when taking it out.

10. Take the power cable plug (6) out of the socket (7) on the battery.
11. Insert the cap (5) that covers the battery power socket.

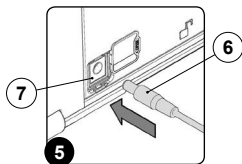

PREPARING THE APPLIANCE

1. Take the package to the dedicated maintenance area.
2. Remove the appliance and all the accessories from the box.
3. Insert the lower tube (1) of the control handlebar in the hole on the joint (2) (Fig.1).
4. Fix the handlebar to the joint using the screw and nut (3), making sure the hole on the handlebar coincides with the hole on the joint (Fig.2).

5. Block the handlebar in the horizontal position. Rest your foot on the main part of the appliance to prevent it from tilting, then push the handle away from you until it snaps into the horizontal position (Fig.3).

⚠ ATTENTION: do not rest your foot on the main switch.

⚠ ATTENTION: the screwdriver is not supplied.

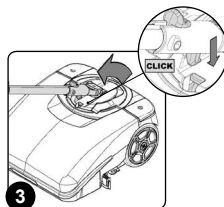
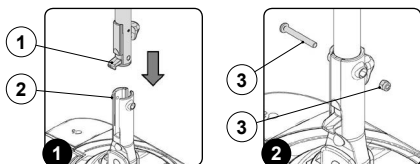

6. Rotate the stop lever of the handlebar (4) in the direction of the arrow (Fig.4).

7. Close the command handlebar, pushing the handle (5) towards the main part of the appliance (Fig.5).

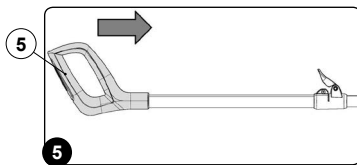
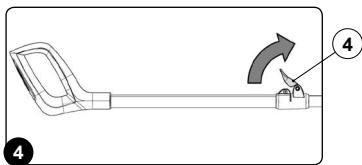

8. Rotate the stop lever of the handlebar (4) in the direction of the arrow (Fig.6).

9. Insert the battery (6) in the battery-holder compartment (7) in the rear part of the appliance (Fig.7). Push the battery until the uncoupling lever (8) locks into place.

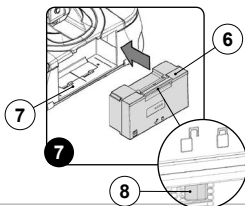
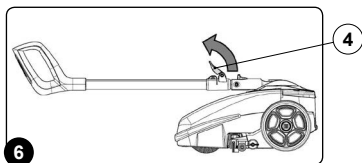

PREPARING TO WORK

Before beginning to work, it is necessary to:

ATTENTION: before beginning the first work cycle, fully recharge the battery (read **"RECHARGING THE BATTERY"**).

1. Before using the appliance, make sure it is in a good, safe working condition. If everything is not in order, the appliance must not be used.
2. Rotate the handlebar so it is vertical.

ATTENTION: During this operation, do not rest your foot on the appliance.

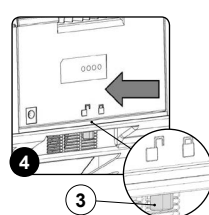
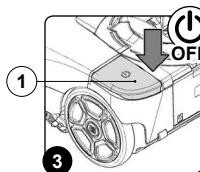
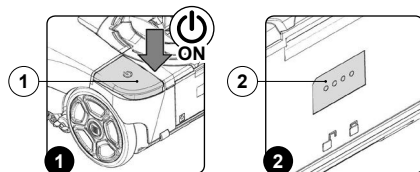

7. Remove the battery from the appliance using the handle moulded on it (Fig.5).
8. Make sure the condition of the squeegee rubbers is suitable for the work you want to carry out. If it isn't, perform the necessary maintenance (read **"MAINTENANCE"**).
9. Make sure the condition of the brush is suitable for the work you want to carry out. If it isn't, perform the necessary maintenance (read **"MAINTENANCE"**).
10. Rotate the front carter (5) as far as it will go - do this with the aid of the handle (6) (Fig.6).

ATTENTION: these operations must be carried out using protective gloves to avoid any possible contact with the edges or tips of metal objects.

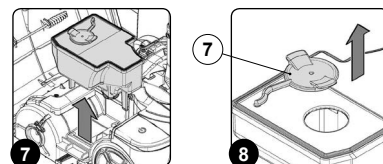
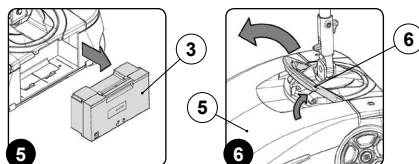

ATTENTION: Always use detergents whose manufacturer's label indicates their suitability for scrubbing machines. Do not use acid or alkaline products or solvents without this indication. Acid or alkaline maintenance detergents can be used, as long as they have pH values between four and ten, and do not contain oxidising agents, chlorine or bromine, formaldehyde, mineral solvents.

ATTENTION: protective gloves should always be worn before handling detergents or acidic or alkaline solutions, to avoid serious injury to the hands.

ATTENTION: always use low-foam detergent. To avoid the production of foam, put a minimum quantity of antifoam liquid in the recovery tank before starting to clean. Do not use pure acids.

3. Activate the appliance using the main switch (1) (Fig.1).

ATTENTION: if the LED of the main switch (1) (Fig.1) is lit up, this means the electrical system of the appliance is activated.

4. Check the battery charge level. There are four LEDs (2) on the battery to show the charge percentage (Fig.2). If all the LEDs are lit up, the battery is fully charged; if they are all switched off, the battery is completely run down.
5. Deactivate the appliance using the main switch (1) (Fig.3).
6. Remove the power battery (3) from the appliance. To free the battery, shift the stop lever (4) in the direction of the arrow (Fig.4).

11. Remove the solution tank from the device (Fig.7). Carefully place it on the floor.
12. Remove the detergent solution filling cap (7) from its seat on the solution tank (Fig.8).
13. Fill with clean water, at a temperature no higher than 50°C and no lower than 10°C.
14. Add the liquid detergent to the solution tank in the concentration and manner indicated on the detergent manufacturer's label.

ATTENTION: The formation of excess foam could damage the vacuum motor, so use only the minimum amount of detergent that is necessary.

15. Replace the detergent solution filling cap (7) in its seat on the solution tank (Fig.9).

ATTENTION: it is good practice to empty the recovery tank every time you top up the solution tank level.

16. Insert the solution tank in the device (Fig.10).
17. Rotate the front carter (5) as far as the work position - do this with the aid of the handle (6) (Fig.11).
18. Insert the battery in the battery-holder compartment in the rear part of the device.

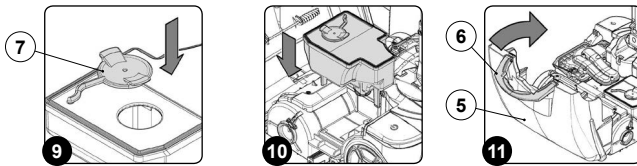

WORK

Before beginning to work, it is necessary to:

1. Carry out the operations described in the [“PREPARING TO WORK”](#) chapter.
2. Check that the squeegee body is in contact with the surface to be cleaned. If it isn't, turn the knob (1) in the direction of the arrow (Fig.1).

ATTENTION: Fig.1 shows the left side of the device. Rotate the knob on the right-hand side in the opposite direction.

3. Release the handlebar from its vertical position and rotate it towards you.

ATTENTION: During this operation, do not rest your foot on the appliance.

4. Adjust the control handlebar.
5. Activate the appliance using the main switch (2) (Fig.2).

ATTENTION: if the LED of the main switch (2) (Fig.2) is lit up, this means the electrical system of the appliance is activated.

ATTENTION: as soon as the device has been activated, the front LEDs will light up and both the brush motor and the vacuum motor will start working.

6. Activate the detergent solution supply by pressing the electric pump control switch (3) (Fig.3).

ATTENTION: if the LED of the electric pump control switch (3) (Fig.3) is active, this means the pump will supply detergent solution.

7. The appliance will now begin to work with full efficiency until the battery is flat or until the detergent solution runs out.

ATTENTION: the joint on the device guarantees greater manageability. To make a left-hand turn, rotate the handle to the left (Fig.4); rotate it to the right when you want to turn right.

ATTENTION: if you need to turn back while you are working, just rotate the device by 180° by rotating the control handle.

ATTENTION: if the handlebar is placed in the idle position (vertical) during use, the brush motor and electric pump will stop working. After a few seconds, the vacuum motor will switch off as well.

ATTENTION: if the charge level reaches a certain value during use, the brush motor and the electric pump will stop working. After a few seconds, the vacuum motor will switch off automatically as well. Both the LED of the main switch and that of the electric pump control switch will remain ON.

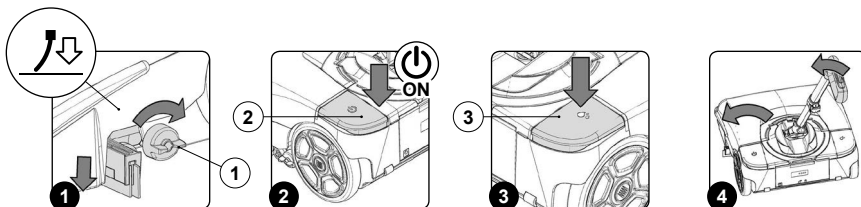

AT THE END OF THE WORK

At the end of the work, and before carrying out any type of maintenance, perform the following operations:

1. Deactivate the appliance using the main switch (1) (Fig.1).
2. Rotate the handlebar so it is vertical.



ATTENTION: During this operation, do not rest your foot on the appliance.

3. Raise the squeegee off the floor and rotate the knob (2) in the direction of the arrow (Fig.2).



ATTENTION: Fig.2 shows the left side of the device. Rotate the knob on the right-hand side in the opposite direction.



ATTENTION: The place this operation is carried out should comply with current environmental protection regulations.

5. Remove the power battery (3) from the appliance. To free the battery, shift the stop lever (4) in the direction of the arrow (Fig.3).

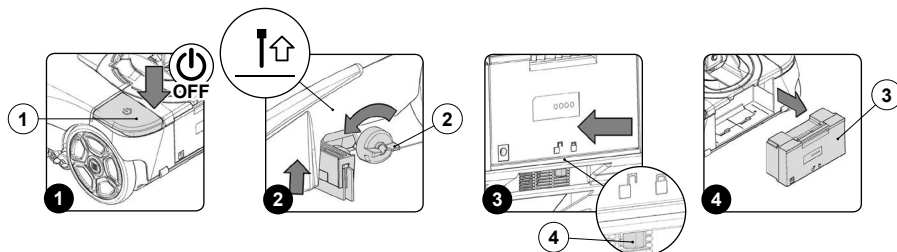

6. Remove the battery from the appliance using the handle moulded on it (Fig.4).
7. Rotate the front carter (5) as far as it will go - do this with the aid of the handle (6) (Fig.5).



ATTENTION: these operations must be carried out using protective gloves to avoid any possible contact with the edges or tips of metal objects.

8. Remove the recovery tank (7) from the appliance - do this with the aid of the handle (8) (Fig.6).
9. Remove the recovery tank cover (9), then rotate the handle (8) completely to free the pin (10) from the clamp (11) (Fig.7).



ATTENTION: protective gloves should always be worn before handling detergents or acidic or alkaline solutions, to avoid serious injury to the hands.

10. Empty the tank.
11. Rinse the inside of the tank with a jet of water. If necessary, use a spatula to remove the sludge that has accumulated at the bottom.
12. Position the recovery tank cover (9) on the tank.
13. Fix the cover on the tank, then rotate the handle (8) completely to fix the pin (10) on the clamp (11).
14. Remove the solution tank from the device (Fig.8).

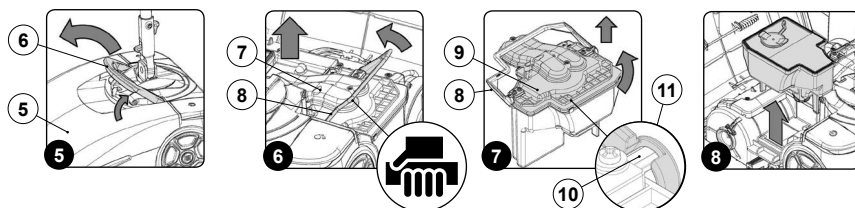

15. Remove the detergent solution filling cap (12) from its seat on the solution tank (Fig.9).
16. Empty the tank.
17. Rinse the inside of the tank with a jet of water.
18. Replace the detergent solution filling cap (12) in its seat on the solution tank (Fig.10)

19. Insert the two tanks in the appliance, positioning first the solution tank and then the recovery tank.
20. Rotate the front carter (5) as far as the work position - do this with the aid of the handle (6) (Fig.11).
21. Block the handlebar in the horizontal position (Fig.12).

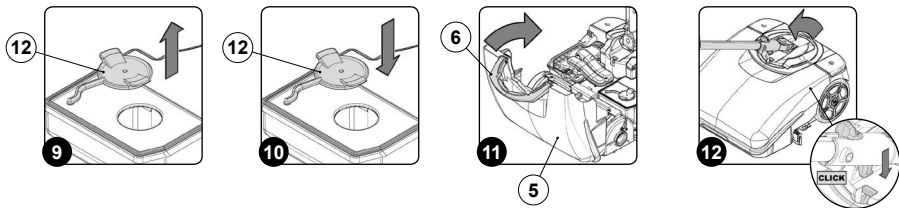

! ATTENTION: During this operation, do not rest your foot on the appliance.

22. Rotate the stop lever of the command handlebar (13) in the direction of the arrow (Fig.13).
23. Close the command handlebar, pushing the handle (14) towards the main part of the appliance (Fig.14).
24. Rotate the stop lever of the command handlebar (13) in the direction of the arrow (Fig.15).

25. Take the appliance to the designated storage area.
26. Position the appliance with its rear part in contact with the floor (Fig.16).

! ATTENTION: Park the appliance in an enclosed place, on a flat surface; near the appliance there must be no objects that could either damage it, or be damaged through contact with it.

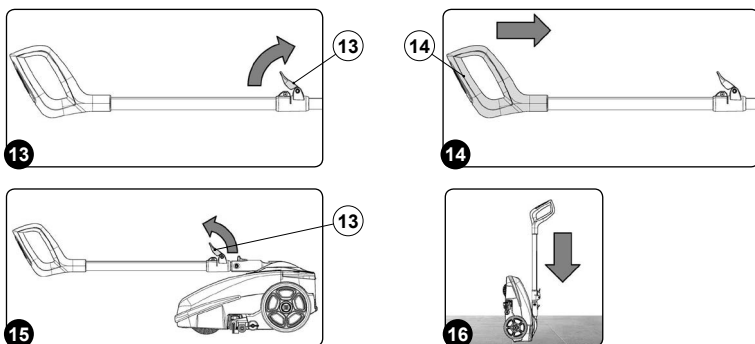

MAINTENANCE

At the end of the work, and before carrying out any type of maintenance, perform the following operations:

1. Deactivate the appliance using the main switch (1) (Fig.1).
2. Rotate the handlebar so it is vertical.

! ATTENTION: During this operation, do not rest your foot on the appliance.

3. Take the device to the dedicated maintenance area.

♻️ ATTENTION: The place this operation is carried out should comply with current environmental protection regulations.

4. Remove the power battery (2) from the appliance. To free the battery, shift the stop lever (3) in the direction of the arrow (Fig.2).
5. Remove the battery from the appliance using the handle moulded on it (Fig.3).
6. Rotate the front carter (4) as far as it will go - do this with the aid of the handle (5) (Fig.4).

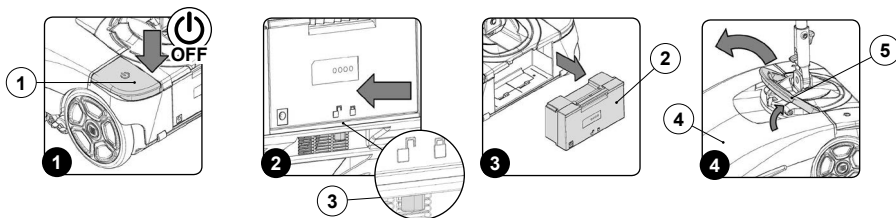



ATTENTION: these operations must be carried out using protective gloves to avoid any possible contact with the edges or tips of metal objects.

- Remove the tunnel cover (6) and shift the stop levers (7) as indicated by the arrows (Fig.5).
- Remove the brush (8) from the appliance (Fig.6).



ATTENTION: during this process, keep the control handlebar still, in order to prevent the appliance from moving accidentally.

- Clean the brush under running water to remove any impurities present in the bristles. Check that the bristles are not worn; in the event of excessive wear, replace the brush (the bristles should be at least 10 mm long).
- Fit the brush (8) on the pin in the brush motor (the brush can only be inserted in one direction) (Fig.7).
- Replace the tunnel cover (6) and shift the stop levers (7) as indicated by the arrows (Fig.8)

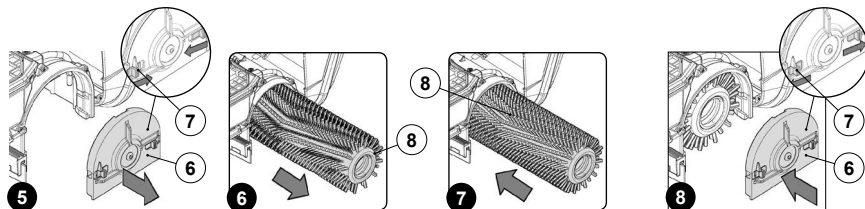

- Remove the recovery tank (9) from the appliance - do this with the aid of the handle (10) (Fig.9).
- Remove the recovery tank cover (11), then rotate the handle (10) completely to free the pin (12) from the clamp (13) (Fig.10).

- Use a jet of water and then a damp cloth to thoroughly clean the rotation fulcrum (14) of the vacuum motor floats (Fig.11).
- Use a jet of water and then a damp cloth to thoroughly clean the central float (15) (Fig.12).

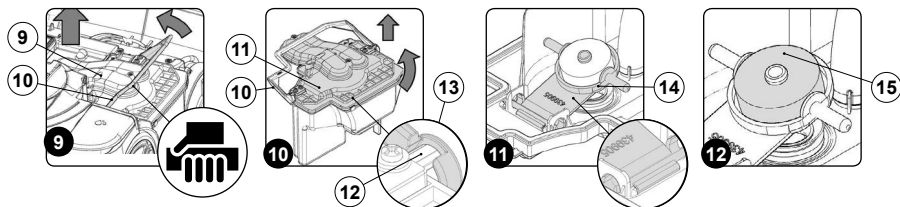

- Clean the dirty water conveyor compartment with a jet of water, the entrance hole to this compartment is identified by the letter (A), while the outlet is identified with the letter (B) (Fig. 13).
- Clean the vacuum motor air conveyor compartment with a jet of air, the entrance hole to this compartment is identified by the letter (C), while the outlet is identified with the letter (D) (Fig. 14).

- Fix the cover on the recovery tank, then rotate the handle (10) completely to fix the pin (12) on the clamp (13).
- Remove the solution tank from the device (Fig.15).
- Remove the filter cartridge (17) and clean it under a jet of water to remove any impurities that might be attached. If necessary, replace it (Fig.16).

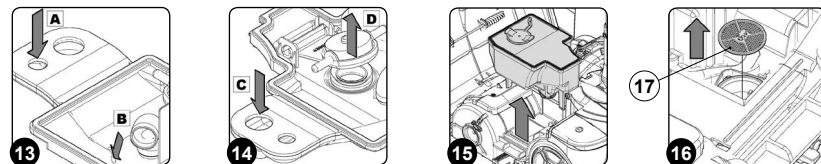

- Remove the vacuum duct cleaning brush (18) from its support (Fig.17).
- Clean the inside of the vacuum duct (19) with the brush (18) (Fig.18).

- Replace the vacuum duct cleaning brush (18) in its support (Fig.19).
- Rotate the front carter (4) as far as the work position - do this with the aid of the handle (5) (Fig.20).

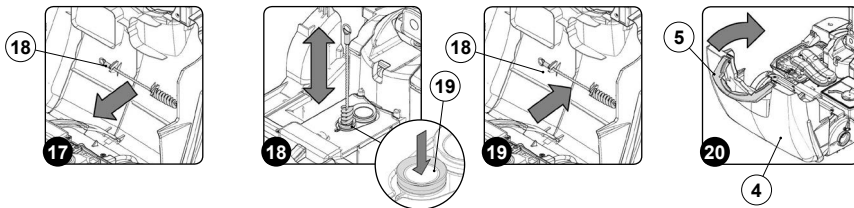

25. Block the handlebar in the horizontal position (Fig.21).

ATTENTION: During this operation, do not rest your foot on the appliance.

26. Rotate the stop lever of the command handlebar (20) in the direction of the arrow (Fig.22).

27. Close the command handlebar, pushing the handle (21) towards the main part of the appliance (Fig.23).

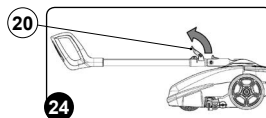
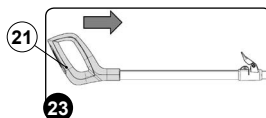
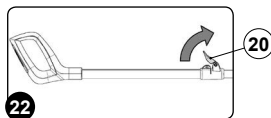
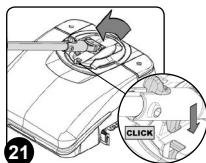

28. Rotate the stop lever of the command handlebar (20) in the direction of the arrow (Fig.24).

29. Position the appliance with its rear part in contact with the floor (Fig.25).

30. Make sure the squeegee is in the work position. If it isn't, rotate the knob (22) in the direction of the arrow (Fig.26).

ATTENTION: Fig.26 shows the left side of the device. Rotate the knob on the right-hand side as well.

31. Bring the squeegee coupling to the maintenance position and shift the knob (22) outwards (Fig.27). Rotate the squeegee coupling towards you (Fig.28).

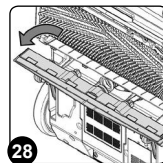
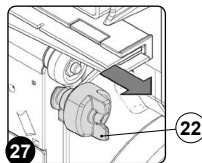
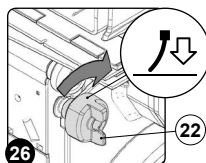
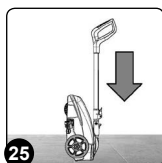

ATTENTION: carry out this operation for both the left-hand knob and the right-hand knob.

32. Use a damp cloth to thoroughly clean the vacuum nozzle duct (23) (Fig.29).

ATTENTION: be careful not to lose or damage the seal (24) above the vacuum nozzle (Fig.29).

33. Use a damp cloth to thoroughly clean the vacuum chamber of the squeegee (25) (Fig.30).

34. Use a damp cloth to thoroughly clean the front rubber (26) of the squeegee (Fig.31). Check the condition of the front rubber blade; if the edge that is in contact with the floor is worn, replace it.

35. Use a damp cloth to thoroughly clean the rear rubber (27) of the squeegee (Fig.32). Check the condition of the rear rubber blade; if the edge that is in contact with the floor is worn, replace it.

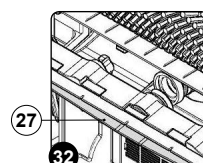
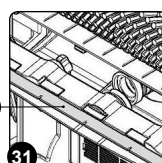
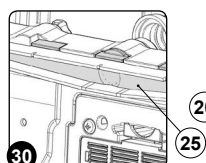
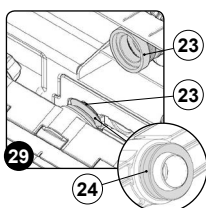

Careful maintenance of the squeegee rubbers guarantees better cleaning and drying of the floor, as well as a longer vacuum motor life. To replace the squeegee rubbers, proceed as follows:

- Turn the wing nuts (28) that hold the squeegee by 90° (Fig.33).
- Remove the squeegee from the slots on the squeegee connector, taking care not to lose the seal on the vacuum nozzle (Fig.34).

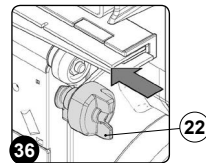
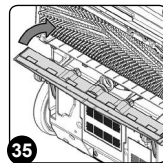
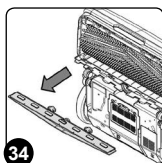
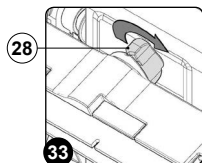

- Replace the worn/damaged rubber.
 - Repeat the operations in reverse order to reassemble all the parts.
36. Bring the squeegee coupling to the idle position and shift the squeegee towards the appliance (Fig.35).
37. Fix the squeegee coupling in the idle position. Push the knob (22) towards the appliance (Fig.36), then rotate it in the direction of the arrow (Fig.38).

ATTENTION: Fig.37 shows the left side of the device. Rotate the knob on the right-hand side in the opposite direction.

38. Remove the exhaust air filter support (29) from the appliance by pressing the fixing tab (30) in the direction of the arrow (Fig.38).
39. Clean the filter cartridges (31) with a jet of air (Fig.39), from a distance of at least 20 cm.

Careful maintenance of the exhaust air filters guarantees a longer vacuum motor life. To replace the filter cartridges, proceed as follows:

- Remove the filter cartridge supports (32) from the filter support (Fig.40).

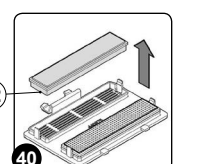
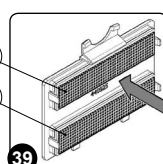
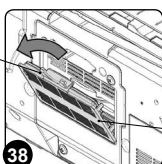
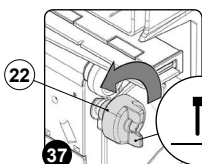

- Remove the worn filter cartridge (31) from the filter cartridge support (32) and replace it with the new one (Fig.41).
- Repeat the operations in reverse order to reassemble all the parts.

40. Insert the exhaust air filter support (29) in the appliance (Fig.42).
41. Rotate the appliance to its work position (Fig.43).
42. Block the handlebar in the vertical position; to release the handlebar, move the stop (33) in the direction of the arrow (Fig.44).

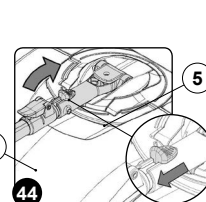
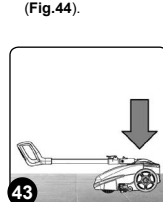
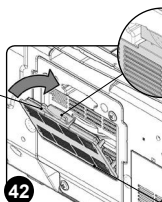
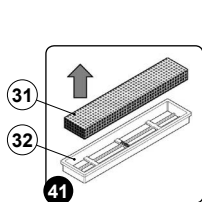

43. Rotate the front carter (4) as far as it will go - do this with the aid of the handle (5) (Fig.45).
44. Insert the two tanks and the detergent solution filter cartridge in the appliance, positioning first the detergent solution filter cartridge, then the solution tank, and finally the recovery tank.
45. Rotate the front carter (4) as far as the work position - do this with the aid of the handle (5) (Fig.46).
46. Insert the battery in the battery-holder compartment in the rear part of the appliance (Fig.47).

47. Position the appliance with its rear part in contact with the floor (Fig.48).

ATTENTION: Park the appliance in an enclosed place, on a flat surface; near the appliance there must be no objects that could either damage it, or be damaged through contact with it.

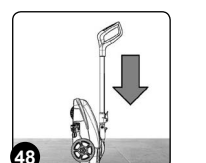
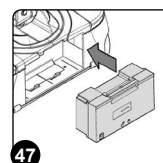
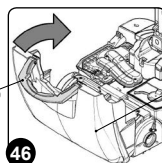
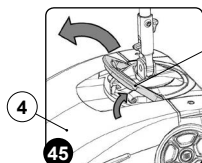

TROUBLESHOOTING

This chapter lists the most common problems linked with the use of the appliance. If you are unable to resolve the problems with the information given here, please contact your nearest assistance centre.

PROBLEM	POSSIBLE CAUSE	SOLUTION
THE APPLIANCE DOES NOT SWITCH ON	The main switch is OFF.	Press the main switch.
	Check that the battery is correctly inserted in the appliance.	Insert the battery correctly in the appliance.
	Check the battery charge level.	If the battery charge level is critical, perform a complete recharge cycle.
THE BATTERY HAS NOT BEEN CHARGED CORRECTLY	The power supply cable plug is not correctly inserted in the battery charger base socket.	Check that the plug on the battery charger power cable is connected to the socket on the battery charger base.
	The power supply cable plug is not correctly inserted in the mains socket.	Check that the battery charger power supply cable plug is connected to the mains socket.
	The power supply network is not compatible with the battery charger requirements.	Check that the features set out of the battery charger information plate match those of the power supply network.
	The LED on the battery charger base flashes repeatedly.	Referring to the battery charger use and maintenance manual, check the meaning of the flashing signals that the battery charger emits during the battery recharge stage.
THE DEVICE HAS A VERY LOW OPERATING AUTONOMY	Check the battery charge level and check the symbol on the control display.	If the battery charge level is critical, perform a complete recharge cycle.
NOT ENOUGH DETERGENT SOLUTION ON THE BRUSH	The quantity of detergent solution in the water system is not sufficient for the work to be carried out.	Fill the solution tank with detergent.
	Detergent solution filter blocked.	Remove the obstructions from the detergent solution filter (read " MAINTENANCE ").
THE DEVICE DOES NOT CLEAN CORRECTLY	The appliance does not switch on.	Read the section " THE APPLIANCE DOES NOT SWITCH ON ".
	The amount of detergent solution dispensed is inadequate.	Read the section " NOT ENOUGH DETERGENT SOLUTION ON THE BRUSH ".
	The brush is not correctly inserted in the appliance.	Insert the brush correctly in the appliance.
	The brush bristles are subject to excessive wear	Check the condition of the brush, and replace it if necessary (read " MAINTENANCE ").
THE SQUEEGEE DOES NOT DRY PERFECTLY	The vacuum device is obstructed	Remove the obstructions from the squeegee (read " MAINTENANCE ").
		Remove the obstructions from the vacuum duct (read " MAINTENANCE ").
		Remove the obstructions from the recovery tank cover (read " MAINTENANCE ").
The recovery tank cover is not positioned correctly.	Position the recovery tank cover correctly.	
EXCESSIVE FOAM PRODUCTION	The detergent being used is not suitable.	Check that a low foam detergent has been used. If necessary, add a small quantity of antifoam liquid to the recovery tank.
	The floor is not very dirty.	Dilute the detergent inside the solution tank.

PROBLEM	POSSIBLE CAUSE	SOLUTION
THE DEVICE DOES NOT VACUUM CORRECTLY	The recovery tank is full	Empty the recovery tank (read "OVERFLOW DEVICE").
	The vacuum device is obstructed	Read the section "THE SQUEEGEE DOES NOT DRY PERFECTLY".

DISPOSAL

To dispose of the appliance, take it to a demolition centre or an authorised collection centre.

Before scrapping the appliance, it is necessary to remove and separate out the following materials, then send them to the appropriate collection centres in accordance with applicable environmental hygiene regulations:

- Brush
- Electric and electronic parts*
- Battery
- Plastic parts

- Metallic parts
- (* In particular, contact your distributor when scrapping electric and electronic parts.



EC DECLARATION OF CONFORMITY



The undersigned company:
Industrial Cleaning Equipment Ltd.
 Sauber House, Unit 3, Rushington Business Park
 Chapel Lane, Totton, Hampshire, SO40 9AH
 Declares under its sole responsibility that the products

FLOOR SCRUBBING MACHINE mod. MOP

comply with the requirements of the following Directives:

- 2006/42/EC: Machinery Directive.
- 2004/108/EC: Electromagnetic Compatibility Directive.

They also comply with the following standards:

- EN 60335-1: Household and similar electrical appliances - Safety. Part 1: Generic standards.
- EN 60335-2-72: Safety of household and similar electrical appliances. Part 2: Specific standards for automatic machines for floor treatment for commercial and industrial use.
- EN 12100-1: Machine safety - Fundamental concepts, fundamental principles for design - Part 1: Basic terminology and methodology.

- EN 12100-2: Machine safety - Fundamental concepts, fundamental principles for design - Part 2: Technical principles.
- EN 61000-6-2: Electromagnetic compatibility (EMC) - Part 6-2: Generic standards – Immunity for industrial environments.
- EN 61000-6-3: Electromagnetic compatibility (EMC) - Part 6-3: Generic standards — Standard emission for residential, commercial and light-industrial environments.
- EN 62233: Household and similar electrical appliances - Electromagnetic fields - Methods for evaluation and measurement.

The person authorised to compile the technical file:

Mr. Mark Bresnihan
 Sauber House, Unit 3, Rushington Business Park
 Chapel Lane, Totton, Hampshire, SO40 9AH

Chapel Lane, 07/01/2015

Industrial Cleaning Equipment Ltd.
 Legal representative
 Mark Bresnihan

Manufacturer: FIMAP S.p.A.

Via Invalidi del Lavoro, n°1
 c.a.p. 37059 - S. Maria di Zevio (VR) - Verona - Italia
 Tel. +39 045 6060411 - Fax. +39 045 6060417

E-mail: fimap@fimap.com

Web: www.fimap.com

Mandatory:

Industrial Cleaning Equipment Ltd.

Sauber House, Unit 3, Rushington Business Park
 Chapel Lane, Totton, Hampshire, SO40 9AH
 Tel. 0800 389 3869 - Fax. 023 8042 8318

E-mail: info@ice-clean.com

Web: www.ice-clean.com



Industrial Cleaning Equipment Ltd.

Sauber House, Unit 3, Rushington Business Park - Chapel Lane, Totton, Hampshire, SO40 9AH
Service 0800 389 3869 - Facsimile 023 8042 8318 - Email info@ice-clean.com